



TURBO s.r.l.

Electronic Control Systems For Dust Collectors  
e-mail: info@turbocontrols.it web: www.turbocontrols.eu  
TEL. ++39 (0)362 574024 FAX ++39 (0)362 574092

# ECONOMIZER

## E2T 24Vdc

25 ÷ 56 OUTPUTS



## User Manual

05/01/2016  
Manual Release 1.00  
Hardware Release 1.01

## General Description

Economizer for controlling the pneumatic cleaning function of industrial dust collection systems.

The pressure differential is digitally controlled by an internal transducer allowing to determine filter obstruction with accuracy.

The device has three output relays contacts and two digital input contacts.

A large, bright display is provided for reading the filter obstruction level, the active solenoid valves and any alarms in any moment.

## Technical Specifications

### Casing

- Made of insulating, ABS base and polycarbonate lid.
- Degree of protection to water and dust: IP65 (EN60529).
- Shock resistance: IK08/07 (8 joule) (EN62262).

### Performance Of The Device

- Dedicated software program, managed by the microprocessor, easy to set up and consult, facilitates the use of the instrument also by users unfamiliar.
- Power voltage 24 Vdc.
- Output voltage 24Vdc.
- LED display with 7 segments, 3 digits 0.8" each.
- Three alarm relay.
- Micro SD memory card for data storage, extractable for consultation. Sampling is performed every 10 seconds, the time interval is editable.
- Four operation modes: manual; automatic; automatic with forced cycle; proportional.
- Operating times expressed in seconds with selectable ranges for any application (option pause time in minutes).
- Pressure measurements expressed in kPa optional in inch Wc.
- Washing function with the fan off (post-cleaning) through the "dP fan" threshold in the automatic/automatic with forced cycle/proportional modes and through contact in the manual mode with up to 99 cycles that can be selected.
- Total and partial hour counter for maintenance.
- Three alarm relays.
- Maximum dP (filter obstructed) alarm.
- Minimum dP alarm (broken sleeve/cartridge), with possibility of inclusion/exclusion.
- Solenoid valve not working alarm.
- Filtering element maintenance deadline alarm (with on/off selection).
- External contact cleaning activation.
- Compressed air presence enable input.
- Pre-coating function (with possibility of inclusion/exclusion).
- 4-20mA output proportional to dP reading for remote pressure reading.
- Manual solenoid valve activation.
- Setting the current date and time associated with the archiving historical data on the SD card, where are stored the detected values.

## Electric Specifications

### Electric Power

- ✧ 24 VDC– 25W

### Selectable Output Voltage

- ✧ 24 Vdc Maximum Load 25 W.

### Inputs And Outputs Galvanically Insulated

- ✧ Enable contact (remote cleaning enable).
- ✧ Fan contact (post-cleaning).
- ✧ 4 – 20mA (dP remote reading).

The solenoid valves connected to the unit are normally closed.

The activation of a solenoid valves causes them to open and let out a jet of air.

### Alarm Relays

The three alarm relays contain 2 clean contacts on terminals 4 ÷ 9 di J4.

Maximum permitted load: 2A @ 24Vdc

### Fuse

1 x 3 A @ 24Vdc.

### Working Temperature

from -10°C to 55°C

### Storage Temperature

-20°C to 60°C

## Timer Specifications:

### Pulse Time (Valve Opening)

from 50 ms to 5 sec

### Pause Time (Interval Between Valve Openings)

1 sec - 999 sec

### Differential Pressure Gauge

Measurable pressure range: from 0 to 4 kPa

Maximum applicable pressure: 16 kPa - 0.16 bar  
(optional sensor 10kPa)

Warning! Read the section on installation before connecting the device.



Warning! Higher pressures will damage the device.  
Do not connect clogging measuring tubes to the compressed air circuit.



## Installation Instructions / Notes And Warnings



- ✧ Protect the device from direct exposure to sunlight.
- ✧ Do not position the device near or directly in contact with sources of heat or electromagnetic fields.
- ✧ Connect the device to power lines other than those for operating motors or other large power devices which could generate network interference.
- ✧ Fix the device of a height of at least 60 cm from the ground.
- ✧ Use flame-retardant cables with a minimum cross-section area of 0.25 mm<sup>2</sup> for all control signals.
- ✧ Check that atmospheric conditions are safe before starting any operation on the device.
- ✧ For electric operations, always remove voltage, wait 30 seconds for the inside capacitors to discharge before opening. At the end of the operations, close the device to restore the correct degree of protection before powering up.
- ✧ Use flame-retardant cables with a minimum cross-section area of 0.75mm<sup>2</sup> to connect to the power supply.
- ✧ Any use not described in this user instruction manual or incorrect use of the device may cause damage to the device or to the devices connected to it.
- ✧ Furthermore, incorrect use or tampering with the device may cause injury.
- ✧ Waterproofness of the casing is guaranteed when the flap is closed.
- ✧ Make sure that rigid or flexible ducts used for wiring, if any, do not fill up with water or other liquids.
- ✧ Any holes made in the casing must be protected by accessories with degree of protection equal to at least that of the economizer.
- ✧ Cut off power supply immediately if water is found in the casing.

Do not use the economizer if you have not read or do not understand this manual.

## Display Keypad

There are four round buttons on the front panel for controlling the device and turning on the display as shown in the following figure.

- The SET button enables to enter and exit the programming menu, and activate the manual test of solenoid valve selected in function F06.
- The + and - buttons enable to scroll functions from F01 to Fxx. After entering one of the Fxx functions use the OK button to select and then + and - increase or decrease the values.
- The OK button is used to confirm data and reset alarms.
- If the + button is pressed during ordinary operation, the activity hour meter is displayed.
- The - Button pressed during the ordinary operation, displays the counts partial hours of activity.
- If the Micro SD Card is inserted, the pressing of the OK button enables safe removal of the card.

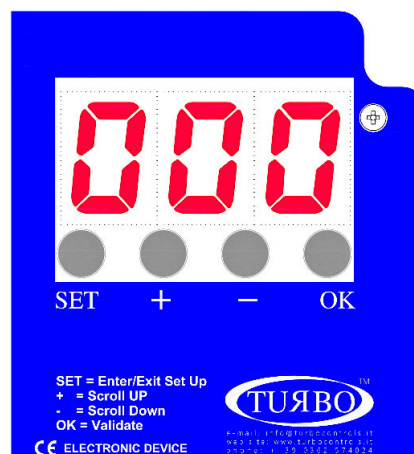

## Menu Diagram

- Press SET, the letter F flashes.
- Press + and - to select the required function.
- Press OK to confirm.
- Increase or decrease the value of the parameter.
- Holding down the + and - buttons to scroll through all the functions until the end of the left or right.
- Press OK to confirm and exit.
- Press SET again to exit programming mode.

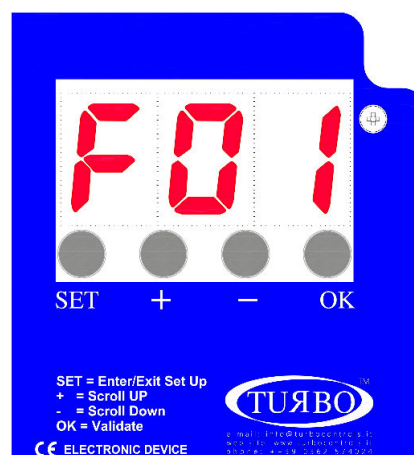

## List of Functions

- **F01:** Configuring the operation mode.
  - Possible values: 0 – Manual (dP excluded)
  - 1 – Automatic (Default) (dP included)
  - 2 – Automatic with forced cycle (dP included)
  - 3 – Proportional (dP included)
- **F02:** Solenoid activation time.
  - Possible values: 0.05” – 5.00” step 0.01”.
  - Default = 0.20”.
- **F03:** Washing pause time between solenoid valves.
  - Possible values: 001” – 999” step 1”.
  - Default = 020”.
- **F04:** Number of connected outputs.
  - Possible values: 01 – 56.
  - depending on the version of the instrument, step 1.
  - Default = 001.
- **F05:** Output voltage setting.
  - Possible values: 24 Vdc.
  - Default = 24 Vdc.
- **F06:** Manual output activation.
  - Possible values: 1 – number of outputs set in F04.
  - Press SET to activate the set output.
- **F07:** Zero dP threshold.
  - Possible values: 0.00 kPa – 3.99 kPa step 0.01.
  - Default = 0.00 kPa.
- **F08:** Cleaning cycle start threshold.
  - Possible values:  
0.00 kPa – 3.99 kPa step 0.01.
  - Default = 0.80 kPa.
- **F09:** Cleaning cycle stop threshold.
  - Possible values: 0.00 kPa – 3.99 kPa step 0.01.
  - Default = 0.40 kPa.
- **F10:** Max dP Alarm Threshold (Filter Clogging)
  - Possible values: 0.00 kPa – 3.99 kPa step 0.01.
  - Default = 3.00 kPa.
- **F11:** Fan on recognition mode.
  - Possible values: 0 from contact – 1 from dP.
  - Default = 1 from dP.
- **F12:** dP threshold for fan on recognition if F11=1.
  - Possible values: 0.00 kPa – 3.99 kPa step 0.01.
  - Default = 0.10 kPa.
- **F13:** Number of post cleaning cycles after stopping the fan.
  - Possible values: 01 – 99 step 1.
  - Default = 01.

- **F14:** Post cleaning mode pause time between solenoid valves (fan off).  
Possible values: 001” – 999” step 1”.  
Default = 010”.
- **F15:** Maintenance frequency expressed in tens of hours  
Possible values: 001 – 999 step 1. (e.g.: 1=10h, 10=100h).  
Default = 100 (=1000h).
- **F16:** Maintenance deadline alarm enable.  
Possible values: 0 (disabled) – 1 (enabled).  
Default = 0 (disabled).
- **F17:** Maintenance hour counter reset.  
Possible values: 0 (disabled) – 1 (reset).  
Default = 0 (disabled).  
**Note:** The maintenance hour counter will be reset and the F17 parameter will be set back to 0 by setting F17 to 1.
- **F18:** Precoating function enabling.  
Possible values: 0 (disabled) – 1 (enabled).  
Default = 0 (disabled).
- **F19:** dP threshold for precoating function.  
Possible values: 0.00 kPa – 3.99 kPa step 0.01.  
Default = 2.00 kPa.
- **F20:** Enabling Minimum dP Alarm function.  
Possible values: 0 (disabled) - 1 (enabled).  
Default = 0 (disabled).
- **F21:** Min dP Alarm Threshold (Broken Sleeve/Cartridge)  
Possible values: 0.00 kPa – 3.99 kPa step 0.01.  
Default = 0.20 kPa.
- **F22:** Selection of minutes or hours for Forced Cleaning Cycle.  
(Only if the operating mode F01 = 2)  
Minutes (0 =minutes, 1 =hours)  
Default = 0 (Minutes)
- **F23:** Setting time interval for Forced Cleaning Cycle in relation to the choice of F22.  
Setting values: 1 - 999 step 1.  
Default = 240 (240 minutes).
- **F24:** Setting the date on the internal clock.  
Settable values: Day 1 – 31 *d*.  
Month 1 – 12 *m*.  
Year 00 – 99 *y*.
- **F25:** Setting of the time for the internal clock.  
Settable values: Hours: 0 – 23 *HH*.  
Minutes: 0 – 59 *mm*.
- **F26:** Exclusion of the valve in short circuit.  
If set to 1 the valve shorted is excluded from the cycle.  
Settable Values 0 (not excluded) - 1 (excluding)  
Default = 0 (not excluded).

## Alarms

The unit runs a number of checks during the start-up cycle and during normal operation. The possible alarms and respective solutions are shown in the following table.

A. Nr.	Description	Action
E01	F05 set to 24Vdc – AC jumper detected	<ul style="list-style-type: none"> <li>- For 24Vdc, switch the device off and move the AC/DC jumpers to DC. Jumper table p. 12.</li> <li>- For 24Vac, press OK, then press SET, set the function F05 using “+” and “-”, select A24 and press OK to confirm.</li> </ul>
E02	F05 set to 24Vac – DC jumper detected	<ul style="list-style-type: none"> <li>- For 24Vac, switch the device off and move the AC/DC jumpers to AC. Jumper table p. 12.</li> <li>- For 24Vdc, press OK, then press SET, set the function F05 using “+” and “-”, select d24 and press OK to confirm.</li> </ul>
E06	Solenoid valve current lower than minimum threshold or disconnected solenoid valve	Check correct connection of the solenoid valve and respective data. The alarm is self-reset.
E07	Solenoid valve current higher than maximum threshold	Check correct connection of the solenoid valve and respective data. The alarm is self-reset.
E08	Output short circuit The signaling of the code E08 alternates with the indication of the interested output is shown as Uxx where xx is the number of the output and the value of dP.	Turn off the device and then turn it back on, after having verified the plant of the solenoid valves.
E09	dP maximum pressure exceeded (F10) Detected for longer than 20 seconds.	Check state of filtering elements.
E10	dP sensor hardware offset out of range.	The self-calibration of the dP sensor has determined that a value is out of range. Disconnect the air tubes and repeat the function. Take the device to be serviced if the alarm occurs again.
E11	Maintenance deadline reached	Carry out maintenance.
E12	dP sensor full-scale value reached Immediate reporting without any delay.	Check state of filtering elements. <b>IMPORTANT:</b> Running in this condition may damage the device.



E13	Minimum dP alarm value ranging from F12 to F21 (warning: the alarm is generated with a fixed delay of 60 seconds).	Check the status of the filtering elements.
E14	<p>Indicates that a valve in short circuit has been excluded from the cycle.</p> <p>The signaling of the code E14 alternates with the indication of the interested output is shown as Uxx where xx is the number of the output and the value of dP.</p> <p>An output is considered a short circuit if not responding for 3 following activations.</p> <p>An activation without error resets the counting.</p>	Turn off the device and then turn it back on, after having verified the plant of the solenoid valves.
E20	Internal clock error.	Replace buffer battery (CR1632 3V 130mAh) and set current time and date.

## Description Of Operation

The installed SW version and the symbol ---, meaning that coherence between settings stored in E2Prom and the set jumpers is being checked, will appear on the display when the economizer is powered up. A corresponding error code will appear in case of discrepancies between settings (see Alarms Table). Only editing functions will be allowed on the unit. The operator may switch off the unit and configure the jumpers correctly.

Symbol **0\_0** will appear on the display if the test is entirely successful. The following pages will then appear:

In automatic mode (F01=1):

dP value alternating with OFF if the enabling contact (14-15) is open

dP value alternating with -0- if the enabling contact (14-15) is closed and the fan is off.

dP value only if the fan is enabled and active.

In manual mode (F01=0):

OFF if the enabling contact is open (14-15)

-0- if the enabling contact (14-15) is closed and the fan is off

### Manual Operating Mode F01=0

The economizer will work as a programmable cycle sequencer in manual mode. The connected outputs will be activated at the programmable frequencies. Manual mode can be activated by accessing the configuration menu and setting F01 to 0. F02 and F03 will set the activation time and the pause time, respectively.

### Automatic Operating Mode F01=1

By selecting automatic mode (F01=1), the economizer will work autonomously can carry out the pneumatic washing cycle only when needed. The device will start the washing cycle if the obstruction is higher than Threshold\_dP\_Start (F08). Washing is suspended when obstruction drops under Threshold\_dP\_Stop (F09) level until it reaches a value higher than the Threshold\_dP\_Start threshold once again. When washing is active, the economizer respects the times set in F02 (operating time) and F03 (pause time).

### Automatic Mode With Forced Cycle F01 = 2

Identical to the automatic mode, except for the fact that it is possible to obtain a cleaning cycle with the activation of the solenoid valves connected without reaching the Threshold\_dP\_Start (F08). The forced cleaning interval may range from 1 to 999 h and can be selected through function F22 and F23.

### **Proportional Mode F01 = 3**

With the proportional mode, the economizer will work in full autonomy, initially setting the dP\_Start threshold (F08), activation time (F02) and pause time (F03). When the Start Cleaning threshold is exceeded, the solenoid valves are automatically activated in sequence. If the dP threshold drops below 15% at the end of an entire cycle of pulses of the connected solenoid valves, the washing is suspended until pressure returns to a value above the Start Cleaning dP value. If the dP value does not drop below 15% of the Start Cleaning threshold, the frequency of the cycle time is automatically reduced in proportion with each entire cycle of pulses of the connected solenoid valves, until a minimum cycle time between solenoid valves reaches 10 seconds. The minimum threshold of 10 seconds has been chosen so as not to hamper the dispensing of air by the compressor connected to the filter.

### **Cleaning Function With Fan Off (PCC)**

This function allows to carry out one or more cleaning cycles (the number of cycles is defined by F13) when the fan is off. The on or off state of the fan may be determined by the state of the contacts 12-13 (contacts open = fan off) if F11=0, or may be determined automatically (with F11=1) when the dP pressure drops under the threshold defined in F12. The pulse time of the valves will always be that defined in F02, while the pause time in this case is defined in F14. The display alternately shows the number of the valve activated and the word PCC.

### **Number Of Output Selection**

The number of outputs (solenoid valves) on which the economizer will run the cleaning cycle can be selected. Cleaning will be carried out in order from the first to the last solenoid valve. The valves can be adjusted by the F04 function.

### **Precoating Function (F18=1)**

This function is used to carry out precoating. Precoating is a filtering element treatment carried out with precoating powder. Washing and manual output activation is suspended during precoating until the precoating thresholds defined in F19 is reached.

The dP value and the message PC (precoating) will appear alternatively on the display.

### **dP Zero Calibration (F07)**

This function is used to reset dP reading with the fan off.

Increase or decrease the value shown by pressing "+" and "-" as required. This value will be subtracted from the value read by the dP sensor.

### **dP Sensor Self-Calibration**

This function allows to reset dP reading with the fan off automatically.

Hold "SET" and "OK" pressed at the same time with the device off. The message "CAL" will appear after the start-up test. Release the buttons. The unit will go back to normal state after a few instants. Automatic calibration is complete.

## **Fuse**

A fuse which can be reset in case of need is located near the power terminal board. Use a delayed fuse 5x20mm as shown in the table on next pages.

## **SD Memory Card**

The Micro SD memory card slot is located on the bottom right of the control unit under the polycarbonate lid.

The card is not supplied with the control unit. A card with a maximum of 32GB can be used.

The card must be formatted FAT32, which is the format recognized by all devices and operating systems.

Before removing the memory card, press the OK button with the control unit on, wait for the cd (card) indication and the alternating flashing of the horizontal lines of the third figure  $\equiv$ . The card can now be safely removed. The Micro SD Card connector is push-pull.

Press upwards and extract the card to remove it.

# Connection Diagram

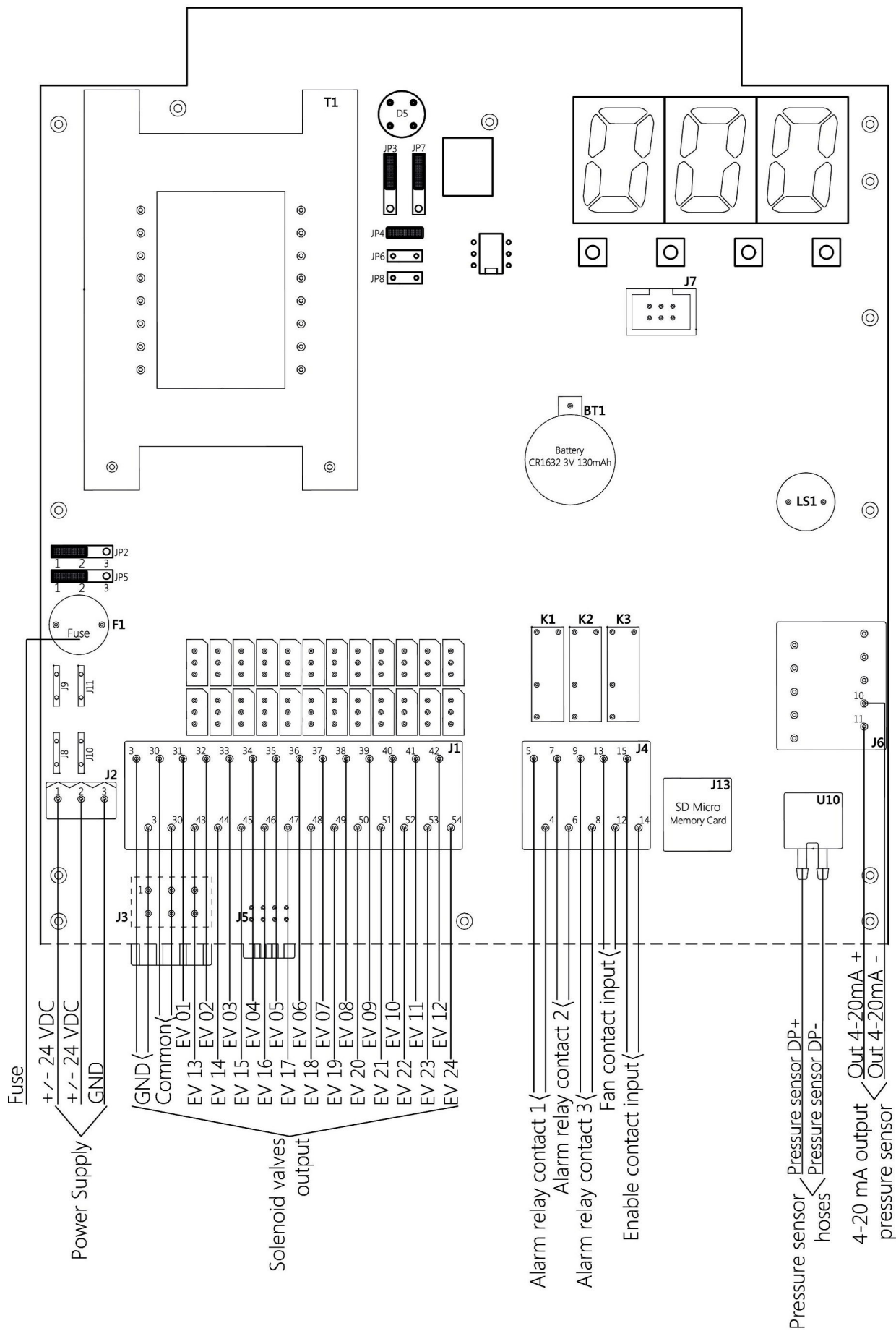

## **Contacts And Relay Terminal Block J4**

Enable contact input consensus 14.15 terminals.

Is used to activate the control unit remotely, it can be turned on and off remotely.

The unit is supplied with a jumper on the two terminals 14:15, without it will not turn on.

Fan contact 12.13 input terminals.

Indicated by the control unit that the plant has been started and is in operation.

The unit is supplied with a jumper on two 12:13 terminals to simulate the state of the plant, as if the fan was turned on.

Alarm Relay K1 4.5 terminals.

The relay is normally closed, opens in case of alarms, and opens to the control unit off in the absence of power.

The alarms that open the relays are:

Problem with solenoid valves E06-E08.

Maintenance interval has been reached.

If one of these occurs, the relay is activated.

Alarm Relay K2 6.7 terminals.

The relay is normally closed, opens in case of alarm, and opens to the control unit off in the absence of power.

The alarm that open the relays is:

Max dP has been reached.

## Connection Diagram Expansions

### Expansion Up To 32 Channels

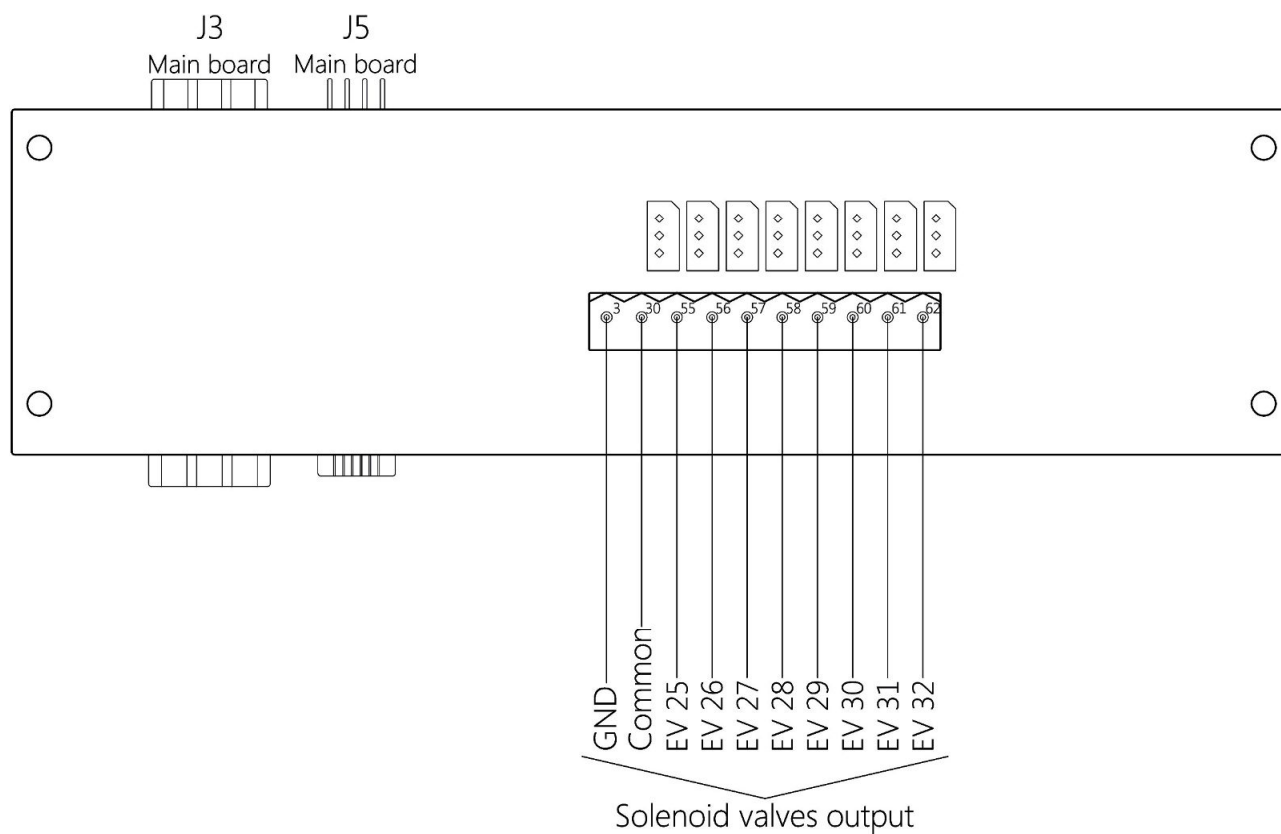

### Expansion Up To 40 Channels

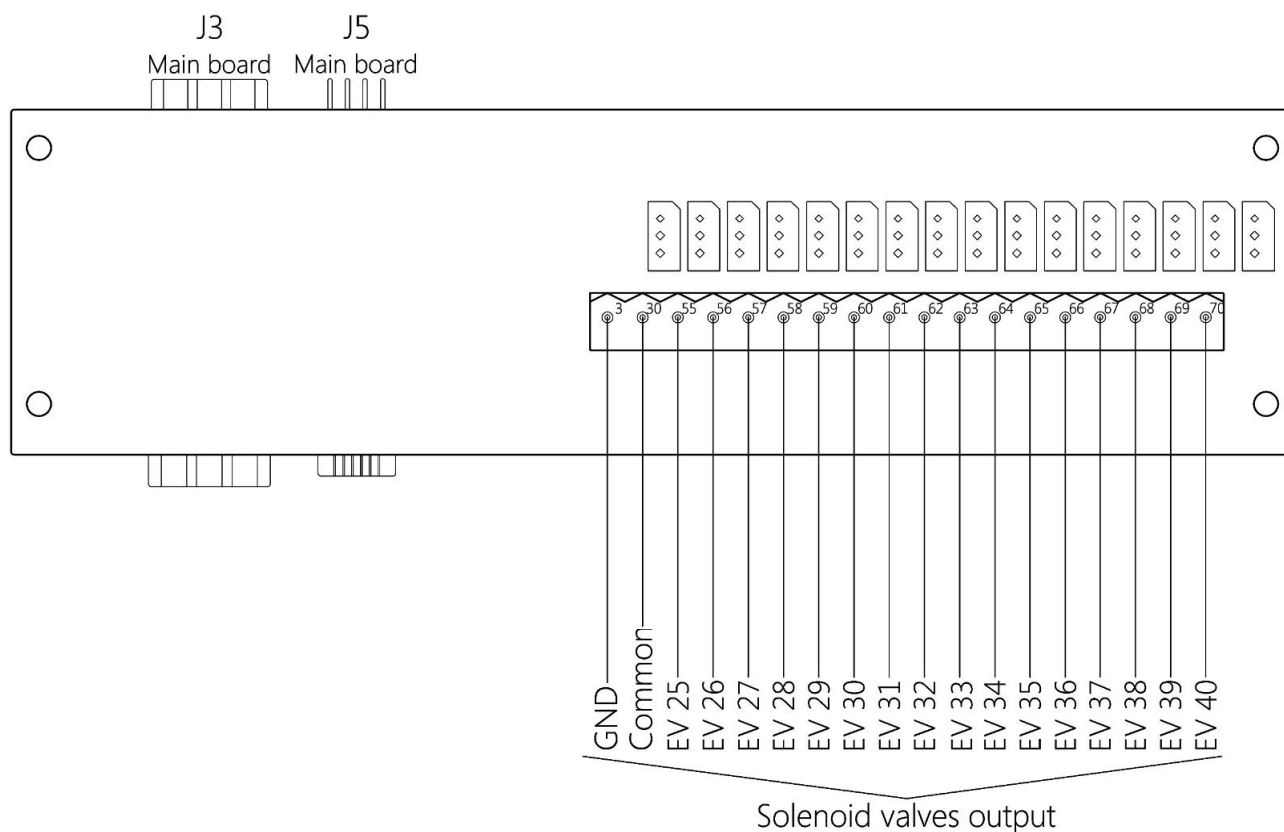

# Expansion Up To 48 Channels

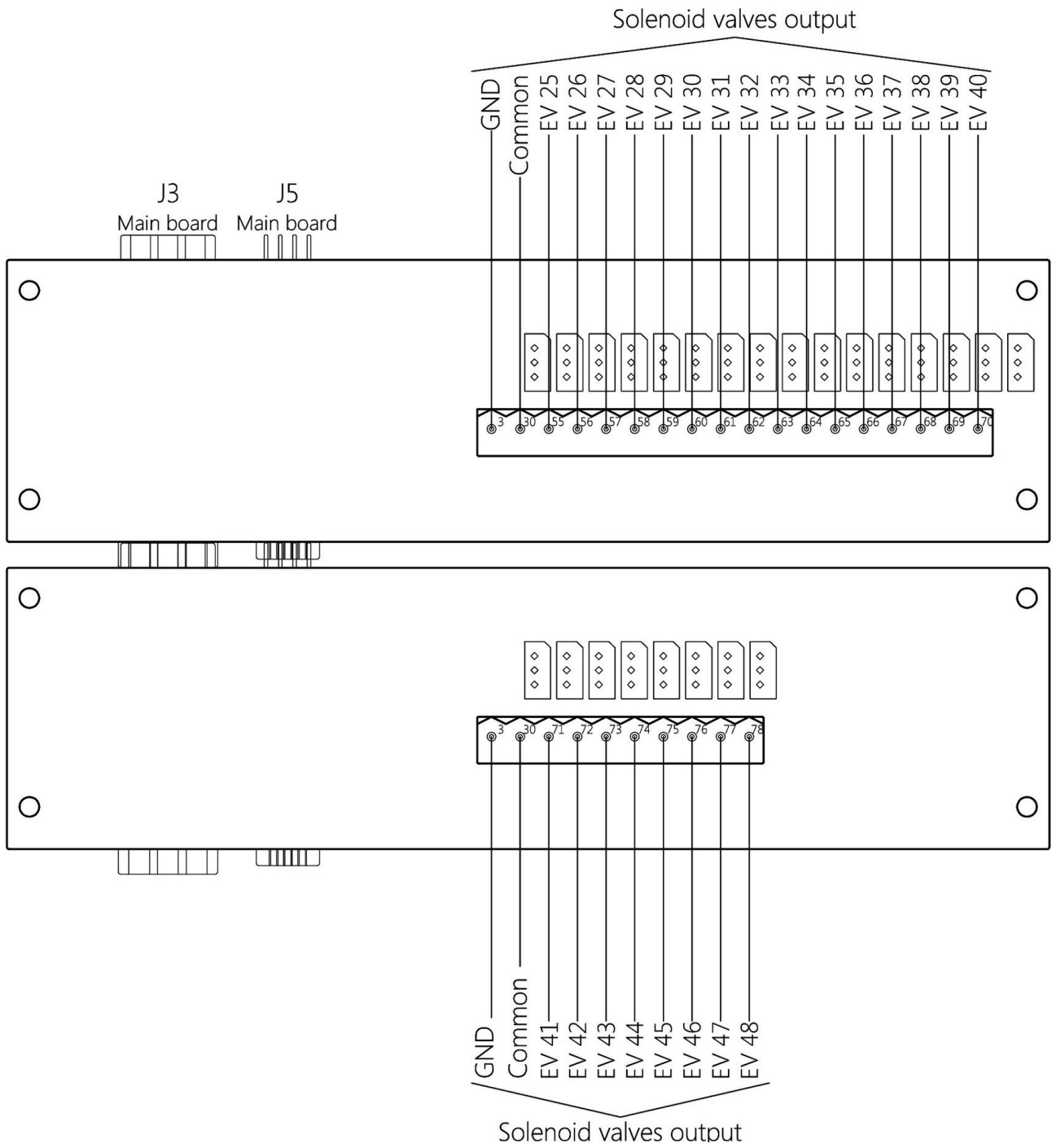



# Expansion Up To 56 Channels

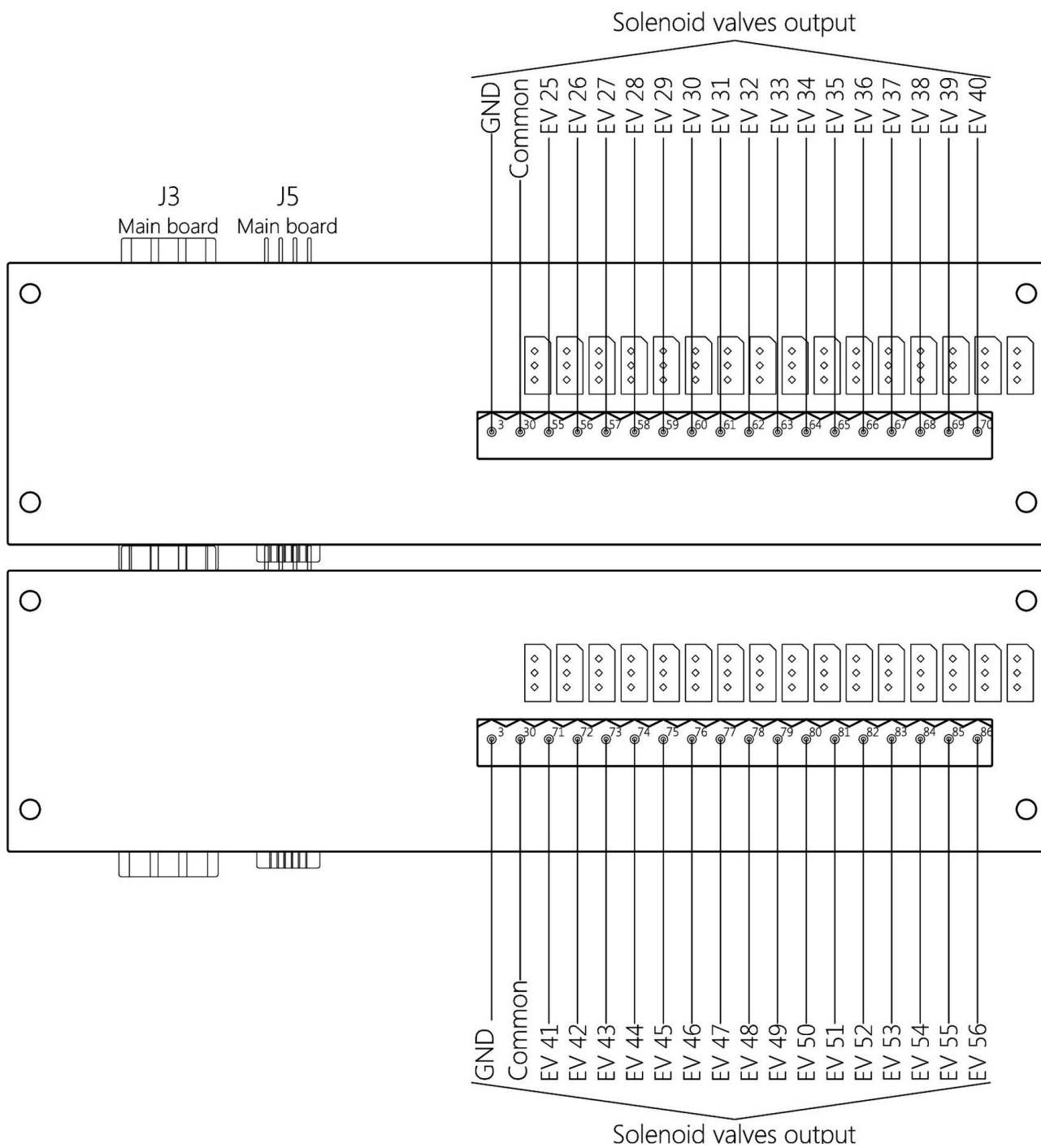

## Terminal Table

To access at the terminal blocks of the control board, unscrewing countersunk screws of the cover panel blue.

Main Board			
Terminal	Description	Terminal	Description
01	Power Supply 24 Vdc	46	Solenoid output 16
02	Power Supply 24 Vdc	47	Solenoid output 17
03	Earth (GND)	48	Solenoid output 18
		49	Solenoid output 19
03	Earth (GND)	50	Solenoid output 20
03	Earth (GND)	51	Solenoid output 21
30	Solenoid valve common	52	Solenoid output 22
30	Solenoid valve common	53	Solenoid output 23
31	Solenoid output 01	54	Solenoid output 24
32	Solenoid output 02		
33	Solenoid output 03	04	Alarm relay contact 01
34	Solenoid output 04	05	Alarm relay contact 01
35	Solenoid output 05	06	Alarm relay contact 02
36	Solenoid output 06	07	Alarm relay contact 02
37	Solenoid output 07	08	Alarm relay contact 03
38	Solenoid output 08	09	Alarm relay contact 03
39	Solenoid output 09	12	Fan input
40	Solenoid output 10	13	Fan input
41	Solenoid output 11	14	Enable input
42	Solenoid output 12	15	Enable input
43	Solenoid output 13		
44	Solenoid output 14	10	4-20mA dP output -
45	Solenoid output 15	11	4-20mA dP output +

### Expansion Boards

Expansion up to 32 channels		Expansion up to 48 channels	
Terminal	Description	Terminal	Description
03	Earth (GND)	03	Earth (GND)
30	Solenoid valve common	30	Solenoid valve common
55	Solenoid output 25	71	Solenoid output 41
56	Solenoid output 26	72	Solenoid output 42
57	Solenoid output 27	73	Solenoid output 43
58	Solenoid output 28	74	Solenoid output 44
59	Solenoid output 29	75	Solenoid output 45
60	Solenoid output 30	76	Solenoid output 46
61	Solenoid output 31	77	Solenoid output 47
62	Solenoid output 32	78	Solenoid output 48
Expansion up to 40 channels		Expansion up to 56 channels	
Terminal	Description	Terminal	Description
63	Solenoid output 33	79	Solenoid output 49
64	Solenoid output 34	80	Solenoid output 50
65	Solenoid output 35	81	Solenoid output 51
66	Solenoid output 36	82	Solenoid output 52
67	Solenoid output 37	83	Solenoid output 53
68	Solenoid output 38	84	Solenoid output 54
69	Solenoid output 39	85	Solenoid output 55
70	Solenoid output 40	86	Solenoid output 56

#### Fuse Table

Voltage	Value
24 Vdc	3 A

#### Jumper Configuration Output

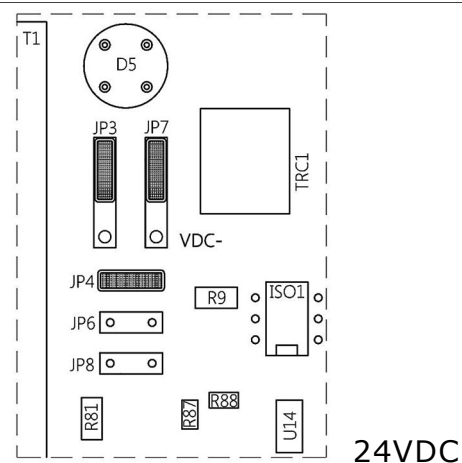

# Installation And Casing Dimensions

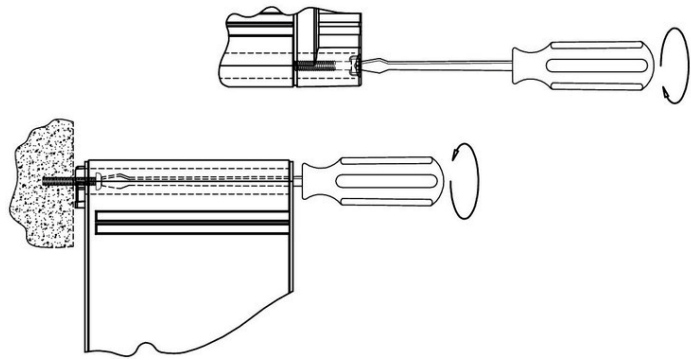
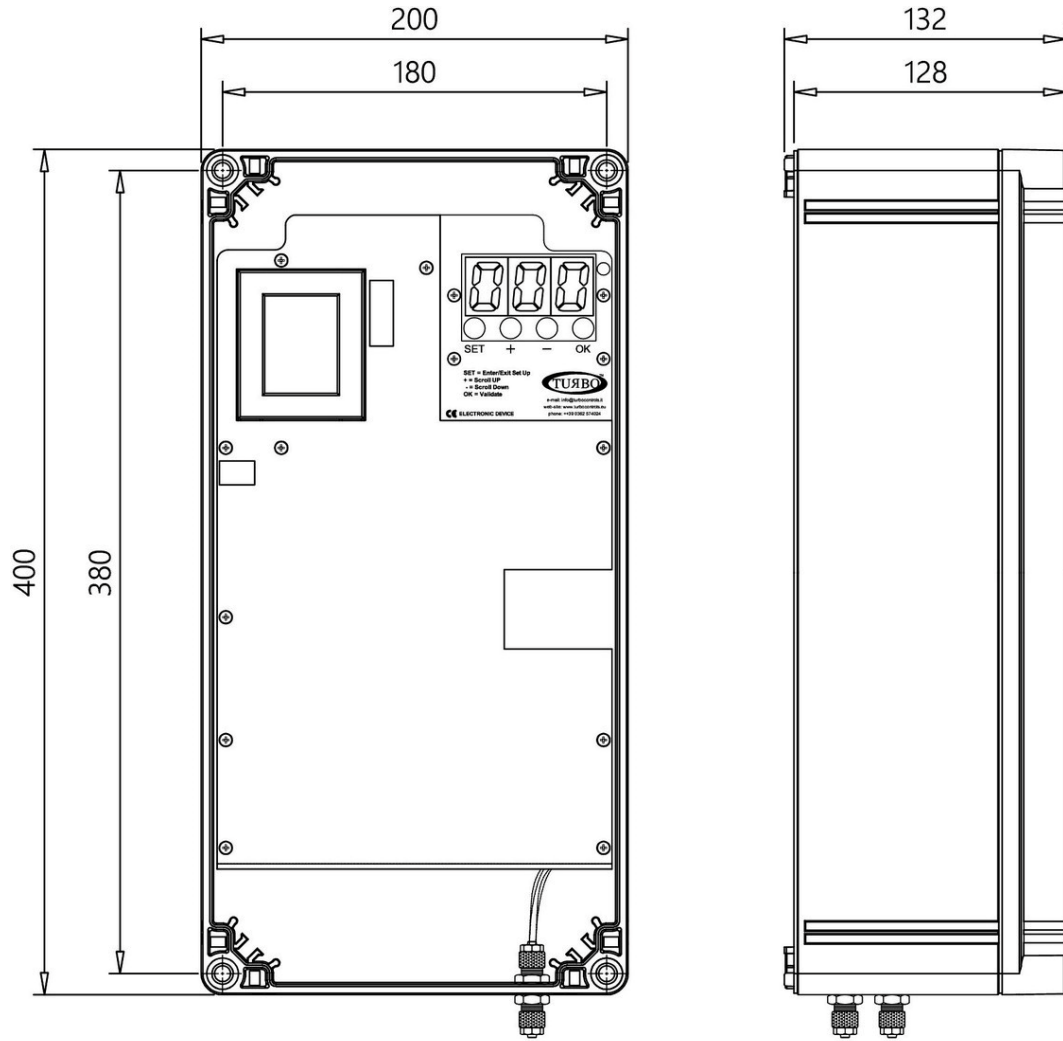

## Maintenance

Only the fuses, batteries and SD card can be replaced.  
All other repairs must be done by the manufacturer.

## Default Settings

Function Number	Description	Set Value
F01	Automatic setting using dP (1) or manual (0)	1
F02	Solenoid valve activation time	0.20''
F03	Washing pause time between solenoid valves in normal cycle	020''
F04	Number of outputs	1
F05	Output voltage: 24 Vdc.	24 Vdc
F06	Manual solenoid valve activation	1
F07	Zero dP threshold	0 kPa
F08	Cycle start dP threshold	0.80 kPa
F09	Cycle stop dP threshold	0.40 kPa
F10	Max. dP level	3.00 kPa
F11	Fan mode: 0 from contact , 1 from dP	1
F12	Fan dP threshold (if F11 = 1). If < fan off	0.10 kPa
F13	Number of cycles after fan stop	1
F14	Pause time between solenoid valves in cycle with fan off	010''
F15	Maintenance frequency in 10h (1=10h, 100=1000h)	100
F16	Maintenance deadline alarm on (1) or off (0)	0
F17	Maintenance hour counter reset: set 1 and confirm to reset the maintenance hour counter	0
F18	Precoating on (1) or off (0)	0
F19	Precoating dP threshold (if F18 = 1).	2.00 kPa
F20	Enabling Minimum dP Alarm function.	0
F21	Min dP Alarm Threshold (Broken Sleeve/Cartridge)	0.20 kPa
F22	Cleaning Cycle Forced (only available in operating mode F01 = 2) Set if it handled in minutes or if in hours.	0
F23	Setting the interval time in relation to the choice of F22	240
F26	Exclusion of valve in short circuit.	0

## Disposal

Do not disperse in the environment after use. Dispose of the product according to current regulations for the disposal of electronic equipment.



This device is used in a dust collector system and, therefore, it is part of a fixed installation.

## Warranty

The warranty has a duration of 2 years. The company will replace any electronic component deemed defective exclusively at our workshop, except in the presence of contrary agreements to be authorized by the company.

## Exclusions From Warranty

The warranty is void in the case of:

- Signs of tampering and unauthorised repairs.
- Incorrect use of the equipment that does not comply with the technical data.
- Incorrect electrical connections.
- Failure to comply with the installation standards.
- Use beyond EC standards.
- Atmospheric events (lightning, electrostatic discharge), over voltages.
- Clogged air connections. Damaged tubes.

## Problem Solution FAQ

FAULT	POSSIBLE CAUSE	SOLUTION
The display does not light up.	Burnt fuse.	Check the protection fuse on the power voltage. Check that the power voltage is present and compliant with that required for the device (terminals 1 and 3).
The outputs are not activated.	Incorrect output voltage. Wiring to solenoid valves.	Check that the unit and solenoid valve output voltage agree. Check wiring between economizer and solenoid valves.
The differential pressure reading is not correct.	Obstructed pneumatic connections. Damaged pipes.	Check that the differential pressure is 0.00 kPa with the pipes disconnected. In this case, check that the connection pipes between device and filter are not obstructed or damaged.
The cleaning cycle is not carried out.	The set cycle start threshold (F08) is too high and therefore the cycle is not activated.	Adjust the start-up pressure threshold or set the economizer to MANUAL mode (F01=0).
Do alarm messages appear?		Check the alarm code with the table.
Do the alarms fail to activate signalling devices?	System wiring errors. No power to alarm devices.	The alarm devices must be powered by voltage external to the economizer. Activating to open the respective relay.
Does post-cleaning start during normal cleaning?	Fan threshold (F12) set too high.	Change the post-cleaning start-up threshold (F12) by lowering it.
Does post-cleaning fail to start when the normal cleaning cycle ends?	Fan threshold (F12) set too low.	Check that the measured pressure is lower than the post-cleaning activation pressure when the fan is off.
Does the economizer occasionally reset?	Check the there is no filtered pulse load on the power line (spot welding machines, welding machines, plasma cutters etc.).	Install a filter on the power line of the economizer, if needed.
The value of 0.0 kPa does not appear on the display when the fan is off.	dP zero calibration (F07) is not correct.	Calibrate the dP zero by appropriately setting the parameter F07 or running the self-calibration function explained on the Operation pages.

## Declaration Of Conformity Of The Manufacturer



**The Manufacturer:**

TURBO s.r.l.

**The Manufacturer's Address:**

Via Po 33/35 20811 Cesano Maderno (MB) Italy

Declares that:

**Product Name:**

Economizer E2T

**Product Options:**

All

Complies with the following directives:

Machinery Directive 2006/42/EC 'Electromagnetic compatibility' compliant with Harmonised European standards EN61000-6-2:2005 class B of EN61000-6-4:2001  
Low Voltage Directive 2006/95/EC compliant with Harmonised European Standards EN 60947-1:2004

A typical configuration of the product was tested.

Cesano Maderno, 05/01/2016

F. MESSINA (C.E.O.)

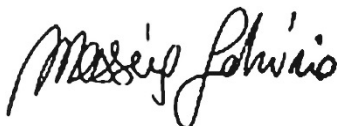

**TURBO s.r.l.**

**Code And Serial Number**