

8" INTEGRAL SERIES WITH 1½" DN VALVES

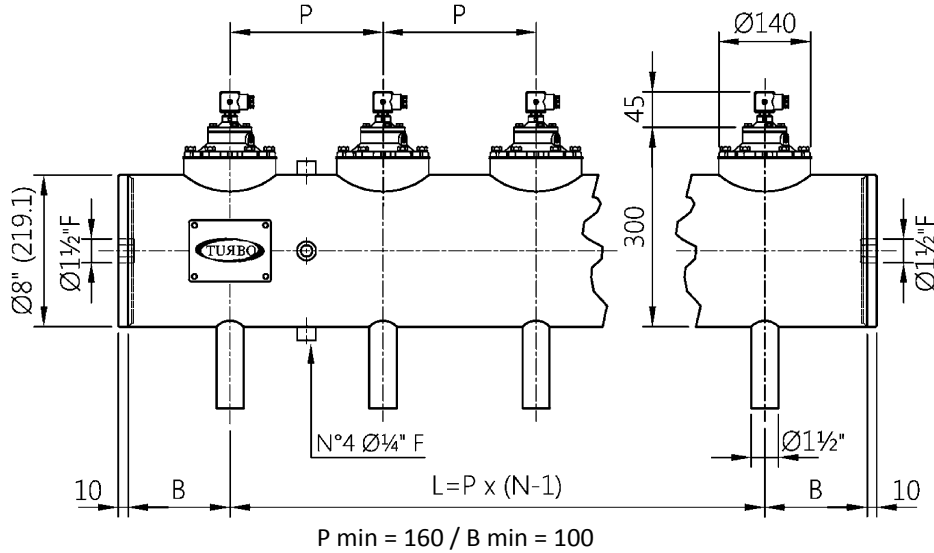

For special versions of P min and B min, please contact our technical department

DESCRIPTION

TI045(N-V-T)P / TI045(N-V-T)M

1	Coil - Connector	BH10 V## / V##
2	Screws - Washers	TKITVTE06X18X4
3	Pilot unit	1331080
4	Pilot cover	1251715
5	Remote cover	1251745
6	Diaphragm spring	3241006
7	Secondary diaphragm (N-V-T)	TKISM010N Neoprene TKISM010V Viton TKISM010T Low temperature
8	Screws - Washers	TKITVTE08X20X6
9	Cover	1251840
10	Diaphragm spring	3241024
11	Primary diaphragm (N-V-T)	TKISM045N Neoprene TKISM045V Viton TKISM045T Low temperature

V## / V## = 24 Vdc - 24 Vac
- 115 Vac - 230 Vac

BRACKETS

CS = COLLAR
SA = HIGH SUPPORT A = 270
SM = MEDIUM SUPPORT A = 210
SB = LOW SUPPORT A = 134

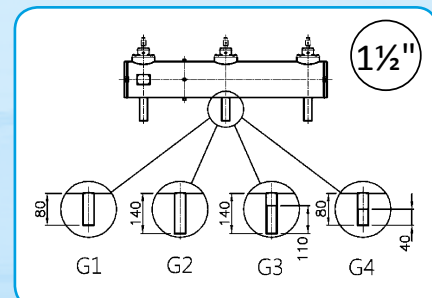
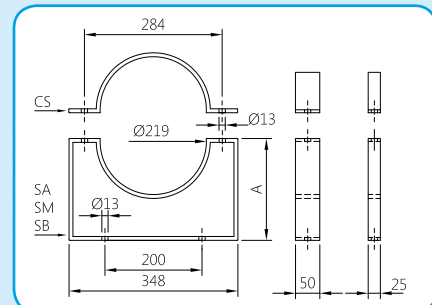

SHORT PLAIN OUTLET PIPE = G1
LONG PLAIN OUTLET PIPE = G2
LONG THREADED OUTLET PIPE = G3
SHORT THREADED OUTLET PIPE = G4

